



**STANFORD
COMPUTER
OPTICS**

Superior imaging intensified CCD cameras



4 Picos

Ultra high speed ICCD camera

200ps highest shutter speed

Best imaging quality

Single photon detection

Compact and light design



www.stanfordcomputeroptics.com



**STANFORD
COMPUTER
OPTICS**



Superior imaging intensified CCD cameras

4 Picos ICCD camera

Ultra high speed intensified CCD camera

Based on more than 25 years of experience in the field of high speed intensified imaging, Stanford Computer Optics, is developing pioneering, ultra fast-gated intensified CCD (ICCD) cameras. The 4 Picos ICCD camera includes cutting-edge electronics and provides ultra high shutter speeds with sub-nanosecond gating time down to 200ps.

More detailed information

Best performance
CCD sensor 4

Time settings
& operation modes 5

Lens coupling 6

How to customize
the best 4 Picos 7

High performance
image intensifier 8

Dimensions & mechanical
data, warranties 10

Applications. 11

High performance and reliable electronics

The 4 Picos ICCD camera is equipped with high resolution image intensifier which provide highest temporal resolution available and excellent sensitivity down to single photons. With quality CCD sensors and high resolution image intensifier the 4 Picos ICCD cameras provide exceptional performance and superior image quality. Long-lasting and reliable electronics ensure trouble-free and undisturbed intensified imaging experience.

Down to 200ps flat top, true optical gating time

In-house developed, custom-built electronics provide extreme low jitter and low propagation delay. The flat top, true optical gating time of down to 200ps is still unique and unrivaled. The extreme low jitter of 10ps and highest accuracy in gate and delay time control of 10ps resolution provides unique capabilities for time resolved measurements.

Unique ICCD camera with picosecond resolution

The adjustable MCP voltage, multiple trigger options and various operation modes make the 4 Picos most flexible and versatile intensified CCD camera. Optionally, the 4 Picos ICCD camera can be equipped with up to 2MHz (on request 5MHz) continuous photocathode gating repetition rate and increased signal amplification using a V-stacked double multi-channel plate (MCP) image intensifier.

Images cover & backside:

A water droplet transformed into the plasma state by a focused Laser beam. The plasma development induce a fast expansion with strong dynamics. The images show the plasma development within the first 40ns after the Laser pulse. The images show a area of 1mm by 1mm and are taken with exposure time of 200ps. Figures reprinted with permission from Fraunhofer ILT, Aachen, Germany.



Standard features and benefits

- Shortest shutter time 200ps
- Gating time from 200ps .. DC
- Internal delay times: 0 .. 80s
- Highly accurate timing control with step size of 10ps
- Extreme low jitter: 10ps
- High resolution image intensifiers with optical system resolution of >60lp/mm
- Spectral sensitivity from UV to red (depends on type of image intensifier)
- Brilliant sensitivity providing single photon detection
- Adjustable MCP voltage for 50db dynamic range in signal amplification
- Multiple exposure operation with up to 3.3MHz (burst mode) and 200kHz (continuous) optical shutter repetition rate
- Customized f/0.8 distortion free lens coupling between image intensifier and CCD
- High dynamic range up to 14bit resolution
- Multiple trigger options: 3x input; 3x output
- USB 2.0 (standard) USB 3.0 (optional) output
- Remote interface for real time camera control
- Compact and light system design
- 4 Spec E software

Optional features

- Nikon F-Mount Adapter
- Two discrete images with double frame mode (fast interframing time 500ns) with P46 phosphor, only
- High photocathode gating repetition rate up to 2MHz continuous; on request up to 5MHz available
- Adapters for various spectrometer
- Vacuum flange for UHV connection

Highlights

Fastest optical gating
down to 0.2ns

Superior image quality by
customized lens coupling

High system sensitivity with
single photon detection

Long-lasting electronics
(24 months warranty)

Compact and light design



Best performance CCD sensors

High resolution, high dynamic range imaging sensors

The 4 Picos ICCD camera features high resolution intensified imaging for sharpest images with 0.2ns true optical gating. The 4 Picos camera provides highest sensitivity with new Gen II high Quantum Efficiency photocathodes and provides the best intensified image quality through customized lens coupling without compromising vignetting, distortion and coupling efficiency. All CCD sensors are front-illuminated types and provide best image quality with low noise and high fill factor.

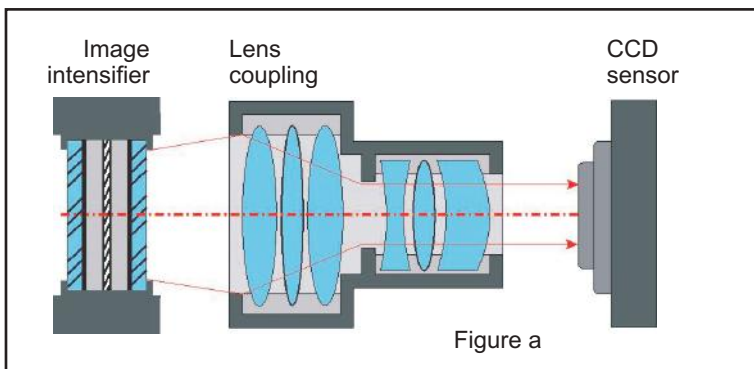

Figure a: Schematic sketch of the lens coupled intensified CCD camera. The appropriate coupling lens images the phosphor screen of the image intensifier to the CCD sensor.

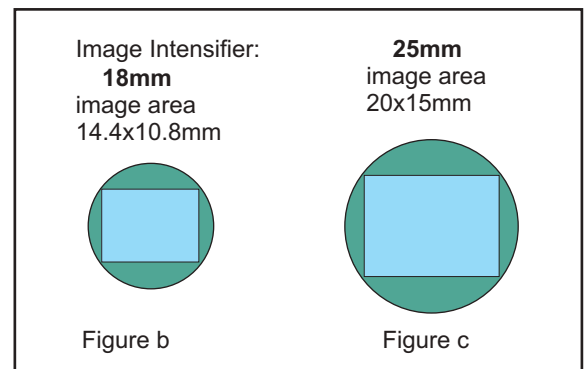

Figure b and c: Lens coupling provides full coverage of the CCD sensor (no dark corners) and highest image resolution.

Automatic continuous cleans

The CCD sensor is automatically cleared before triggering at trigger frequencies below 4Hz. This ensures the best and most efficient reduction of CCD sensor background noise.

High dynamic range

The CCD sensor provides up to 14bit dynamic range. Furthermore, the CCD sensor gain can be adjusted from 0 to 20db. In combination this results to 17bit dynamic range of the CCD sensor.

High fill factor

The interline CCD sensor provide highest fill factors using micro lens arrays on top of the active pixels.

CCD sensor options

Parameter	High resolution HR CCD sensor	Standard resolution SR CCD sensor
Resolution	1360x1024	780x580
Pixel size [µm]	4.7x4.7	8.3x8.3
Camera interface	USB 2.0	USB 2.0
Binning options	full frame, 2 (2x2binning), ROI (region of interest)	
Dynamic range	12 or 14 bit	12 or 14 bitt
Video gain [dB]	full and ROI: 0..20db; 2x2: 0..25db	
Chip readout	Correlated double sampling, dark current corrected	



Time settings

Superior timing control with on-board delay generator

The **on-board digital** delay generator provides accurate timing control of the photocathode gating. All true flat top optical gating times are measured in single shot measurements. These measurements do not include the positive influence of signal jitter in integrating measurements.

Time settings

Parameter	4 Picos
Gate time [step size]	200ps ... 80s [10ps]
Delay time [step size]	10ps ... 80s [10ps]
Jitter	<10ps
Minimal dead time between multiple exposures	300ns
Minimal interframing time (optional double frame mode*)	500ns
Trigger propagation delay	internal gate pulse: 60-65ns external gate pulse: 30-35ns

* image intensifiers with P46 phosphor screen

4 Picos ICCD camera captures the motion of light

The ultra high speed shutter system of the 4 Picos ICCD camera provides shortest gating times down to 200ps flat top at single shot measurements. This feature is unique and enables trapping the motion of light.

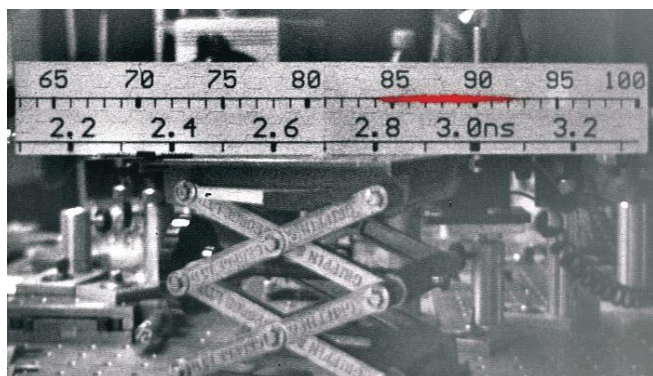

The image shows the distance a femtosecond laser pulse moved along a ruler while the shutter of the 4 Picos camera was open. This distance is a direct measure of the flat top, single shot gating time.

Direct measurement of the gating time.

For the direct measurement of the gating time the 4 Picos ICCD camera is placed perpendicular to a ruler which is pointing in the propagation direction of a femtosecond laser. The width of a fs laser pulse is a fraction of a millimeter and it is moving with the speed of light. Thus the measured distance which the laser pulse travels while the shutter of the 4 Picos camera is open indicates directly the single shot gating time.

Direct measurement versus FWHM specifications

All ICCD cameras from Stanford Computer Optics are indicated with the minimum single shot gating time. In contrast to this direct measurement of the gating time most competing ICCD cameras are stated using FWHM (Full Width Half Maximum) specifications for the shortest gating time. The FWHM specification is determined by integrating a series of laser pulses. Due to the jitter of the camera and the light source the accumulated signal is similar to a Gaussian curve. Hence the specified FWHM gating times are faking shorter times and ignoring the long tails. However, especially these long tails are causing blurred and fuzzy images.

Lens coupling system

The lens coupled ICCD cameras provide superior image quality.

All 4 Picos ICCD cameras are equipped with the in-house developed, customized f/0.8 lens coupling system. It provides superior imaging quality without compromising distortion, resolution and vignetting. In contrast to other claims the lens coupled ICCD camera systems provides single photon detection and high S/N

ratio at low light environment. The stray light is reduced using convenient anti-reflex coatings which results in magnificent optical contrast. Furthermore, in combination with the adjustable MCP voltage it proves high dynamic range, large linearity and ensures a great life span of the imaging system.

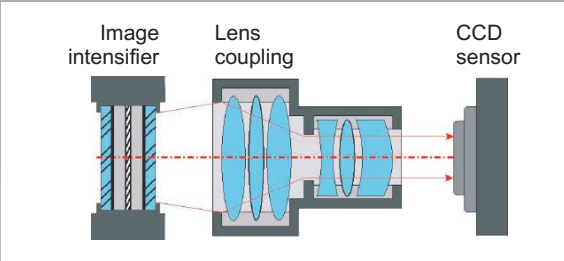
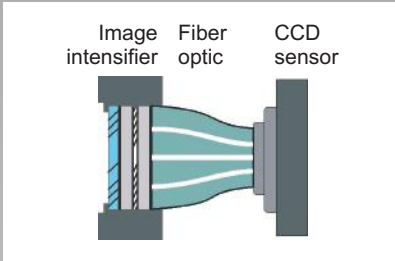
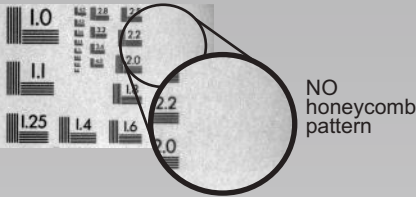
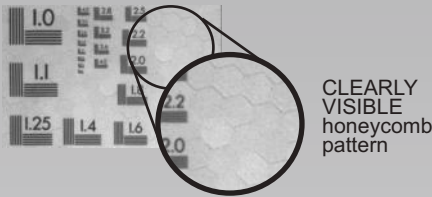
Coupling image intensifier		CCD sensor comparison	
Parameter	F/0.8 lens coupled ICCD camera	Fiber-optic coupled ICCD camera	
			
Example	 <p>NO honeycomb pattern</p>	 <p>CLEARLY VISIBLE honeycomb pattern</p>	
Advantages	<ul style="list-style-type: none"> + excellent coupling efficiency by F/0.8 lens + superior image quality highest modulation transfer function (cut off @ 180lp/mm) NO honeycomb pattern NO vignetting NO distortion (<0.03%) + cost efficient + variable setup (e.g. easy repair and replacement of each single component, especially image intensifier) 	<ul style="list-style-type: none"> + good coupling efficiency + compact design 	
Disadvantages	<ul style="list-style-type: none"> - stretched design 	<ul style="list-style-type: none"> - poor image quality lower modulation transfer function distortion > 3% CLEARLY visible honeycomb pattern - cost intensive - fixed structure e.g. no repair or replacement 	

In summary the fiber-coupled ICCD camera systems provide lower image quality and less flexibility in combination and maintenance. Whereas the often claimed much better coupling efficiency diminish after taking into account the coupling loss, the core-

cladding-ratio of the fibers and the significant loss of the fiber optic due to diameter reduction. On the other hand the customized F/0.8 lens coupling system provides best intensified image quality, high flexibility and excellent coupling efficiency.



4 Picos family

Customize the optimum 4 Picos ICCD camera for your application

The 4 Picos ICCD camera enables the customization to the requirement and needs of your experiment. This guarantees best performance in combination with superior intensified imaging. Please follow the indicated four step process to get the best and most suiting ICCD camera for your application.

Customize the 4 Picos camera in 4 steps:

1. Select the minimum gating time
2. Select the optimum image intensifier
3. Choose the ideal CCD sensor
4. Pick the required accessories

1. Minimum gate time

If the preferred minimum gate time is 200ps the 4 Picos is the “camera of your choice”.

For min gate time in the nano-second regime please see our 4 Quik E ICCD camera.



2. Image intensifier

2.1. Photocathode

- UV high QE
- optional: blue high QE
green high QE, red high QE
(see details on next page)
- input window: quartz
or MgF2 on request

2.2. Multi-channel plate (MCP)

- single or
- dual stage (optional)

2.3. Phosphor screen

- P43 standard
- P46 optional
(requested for 500ns fast
dual frame mode)

3. CCD sensor

3.1. Digital output

- standard: USB 2.0
- optional: USB 3.0 (2019)

3.1. Resolution of CCD sensor

- standard resolution:
780 x 580 pixel
- high resolution:
1360 x 1024 pixel

3.2. Dynamic range of CCD sensor

- 12bit or
- 14bit

Please contact our sales team to get assistance and further details to these options.

4. Selection of optional accessories and adapters

Item-No.	Name of product	Description
LMA-...	lens mount adapter	selection of adapter for various lens mount systems (e.g. F-mount, EOS) providing full aperture and reduced stray light by black anodized aluminum
SGA-...	spectrograph adapter	selection of adapter for all common spectrograph manufacturer e.g. Acton, Horiba and Jobin Yvon, others on request
VF	vacuum flange	customized flange to connect the ICCD camera to any vacuum tube
SMB-BNC	SMB-BNC	SMB - BNC adapter cables in any length
IOL-...	input objective lens	various input objective lenses e.g. Pentax UV lens 25mm, F2.8-16; Pentax UV lens 78mm, F3.8-16F3.8-1, others on request

High performance image intensifier

Guidance to make the right choices in order to get the most suitable image intensifier.

The image intensifier is a key component of each ICCD camera. This section deals with the fundamental characteristics of image intensifiers and their options. Different applications of ICCD cameras have different demands and requirements on the camera and thus on the image intensifier.

Following questions need to be addressed

- What are the spectral characteristics of the illumination?
→ Does determine the suitable photocathode.
- How fast need to be the shutter/shortest gating time?
→ Highest shutter speed does have some constrains to e.g. size of the image intensifier.
- How much light is there?
→ Dual stage MCP's have better performance at low light environments but less .
- High speed or low light imaging?
→ Does determine the suitable phosphor screen.

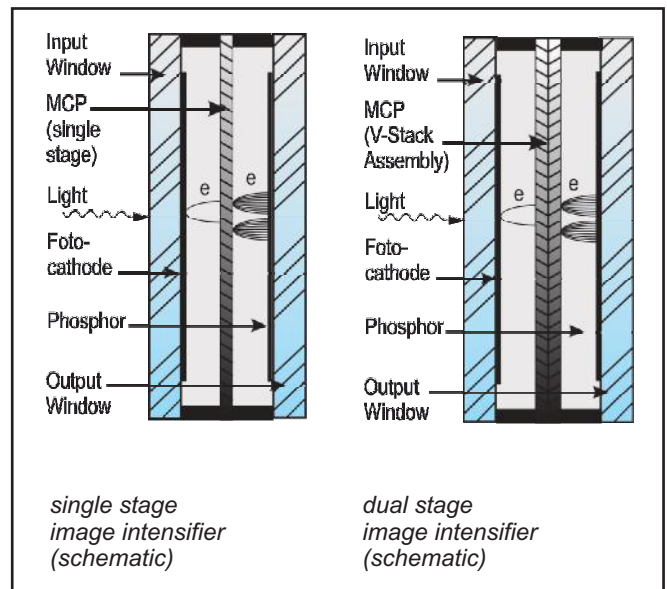

First the incoming photon releases an electron in the photocathode, second the electron is accelerated and amplified to an electron avalanche within the multi-channel plate (MCP), third the accelerated electrons are converted into photons by the phosphor screen.

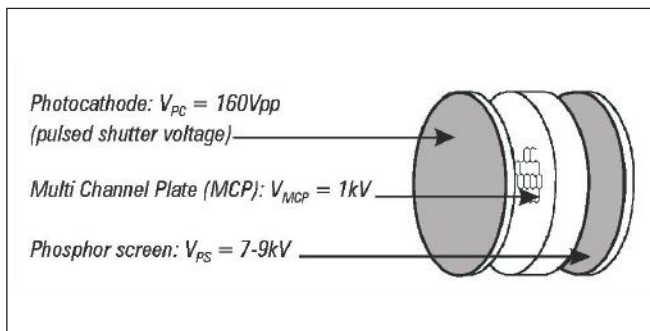

New: Gen II High QE photo cathodes

The new Gen II high Quantum Efficiency photo cathodes are providing the best spectral responsibility performance....

Photocathodes

	Type	Spectral range
Standard	UV High QE	approx. 180 - 700nm
Optional	UV High QE MgF2	approx. 110 - 700nm
	Blue High QE	approx. 200 - 700nm
	Green High QE	approx. 360 - 700nm
	Red High QE	approx. 400 - 900nm



Image intensifier specifications

Shutter speed

The shutter speed is limited by the speed of light since any electromagnetic signal does not travel faster.

Input window

The standard input window is made of quartz. This limits the UV spectral range below 165nm. The optional Magnesium Fluoride (MgF2) window enables measurements down to 110nm.

Photocathode

Photocathodes define the sensitivity and the spectral response of the image intensifier.

Phosphor screen

There are three important considerations in choosing a luminous (phosphor) output screen.

1. spectral emission range
2. efficiency
3. phosphor decay time

The P43 phosphor screen has a higher efficiency, however, a longer decay time. For fast applications e.g. double frame mode with interframing time of 500ns the P46 phosphor screen is necessary to avoid ghost images from the previous exposure.

Multi-channel-plate (MCP)

Image intensifiers can be equipped with single or double stage MCP's. The single stage MCP features excellent signal gain and fits most applications of the ultra high speed ICCD cameras.

The V-stacked double MCP's are especially used for extreme low light environments. The increased electron multiplication provide single photon detection with increased signal to noise ratio and reduced ion feedback noise. Therefore, the double MCP is mainly used for long exposure measurements and extreme low light applications

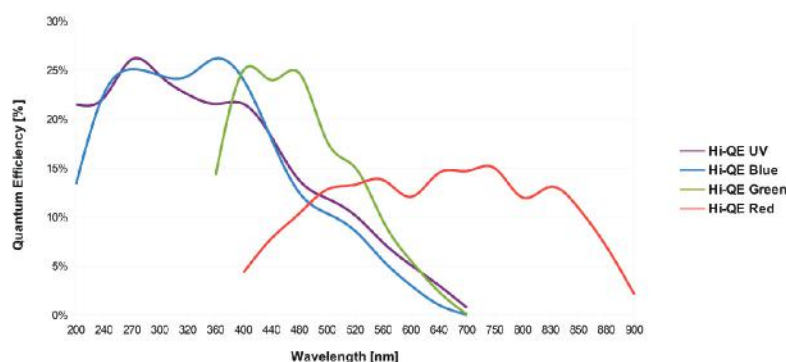
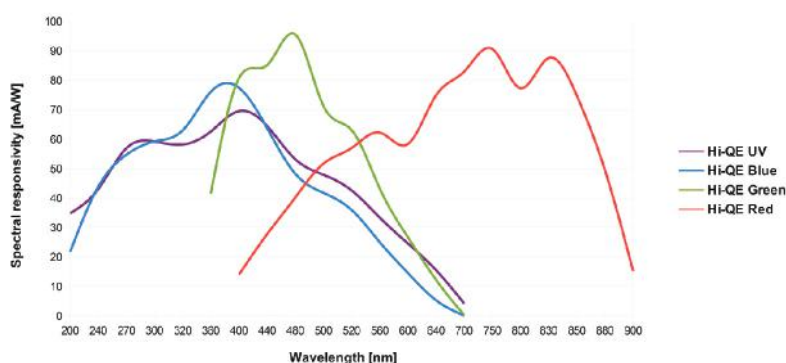

Upper graph: Spectral responsivity [mAW]
Lower graph: Quantum Efficiency [%]

Phosphor screen

Type	Composition	Efficiency	Decay time		Emission spectral range
			90% to 10%	10% to 1%	
P43	Gd ₂ O ₂ S:Tb	185 ph/e @6kV	1.5ms	3.3ms	360 - 680nm
P46	Y ₃ Al ₅ O ₁₂ :Ce	90 ph/e @6kV	0.2μs	10μs	490 - 620nm

Micro-channel-plate (MCP)

Type	Electron multiplication	S/N ratio	Notice
Single stage	up to 10 ³	very good	best image quality
Double stage	up to 10 ⁶	excellent	highest sensitivity

Dimensions

Compact and light design

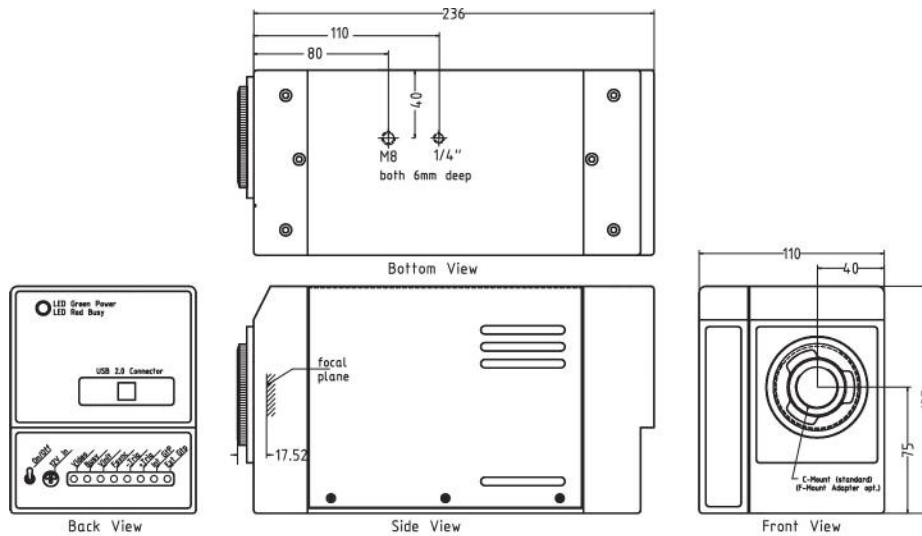

Mechanical and environmental data

Parameter	Description
Camera weight (all in one)	3kg / 6.6lb
Camera dimensions without lens	248 x 110 x 135mm (l x w x h)
Camera mount	1/2" and M8 mounting holes
Operating humidity	25..95%, non condensing
Operating temperature	0°C 50°C / 32°F 122°F
Performance specification	10°C 40°C / 50°F 104°F
Operating limits	-10°C 50°C / 14°F 122°F
Shock and vibration	60g accel. shock, 7g Vibration (11 200Hz), excludes MCP in direct frontal impact
Voltage	90..260VAC

Extended warranty on all products from Stanford Computer Optics

2 years on mechanics and electronics
Stanford Computer Optics Inc. warrants all new products to be free from defects in materials and workmanship for 24 months from the date of dispatch.

1 year on image intensifier
Image intensifiers are subject to the original manufacturer's warranty conditions. It comprises a warranty of 12 months. In case of any defect the Paul Hoess KG or Stanford Computer Optics Inc. will assist for repair or replacement.

Warranty restriction
Warranties do not cover normal wear, misuse, negligence or accident. They do not apply to goods which have been misused, altered, inadequately maintained, stored incorrectly, or negligently installed or serviced.



Applications

4 Picos ICCD camera provides user-friendly intensified imaging for numerous, different applications

Fluorescence lifetime imaging microscopy (FLIM)

e.g. by S. Cheng from the Texas A&M University, United States: *Optics Letters*, Vol. 38, Issue 9, 2013 and Y. Sun from the University of California-Davis, United States: *Optics Letters*, Vol. 34, Issue 13, 2009

Fluorescence resonance energy transfer (FRET)

e.g. by A. L. Rusanov from the Russian Academy of Sciences, Russian Federation: *J. Biophotonics*, Vol. 3, Issue 12, 2010

Fusion reaction diagnostic

e.g. by E. J. Lerner et al., from the Lawrenceville Plasma Physics, Inc., United States: *Phys. Plasmas*, Vol. 19, Issue 3, 2012



The 4 Picos ICCD camera integrated at the experimental setup of the dense plasma focus with the from the backside facing the window of the vacuum chamber. Figure reprinted with permission of the Lawrenceville Plasma Physics, Inc (2012).

Thomson scattering

e.g. by E. R. Kieft from the Eindhoven University of Technology, The Netherlands: *Rev. Sci. Instrum.*, Vol. 76, Issue 5, 2005

Synchrotron beam diagnostic

e.g. by J. C. Bergstrom from the Canadian Light Source, Canada: *Nuclear Instruments and Methods in Physics Research Section A: Accelerators, Spectrometers, Detectors and Associated Equipment*, Vol. 562, Issue 1, 2006

Gated viewing 3D laser radar

e.g. by J.F. Andersen from the Danisch Defense Research Establishment, Denmark: *Applied Optics*, Vol. 45, Issue 24, 2006

Photoluminescence

e.g. by S. I. Hintschich from the University of Durham, United Kingdom: *Journal of Chemical Physics*, Vol. 119, Issue 22, 2003

Light intensity measurements over 11 orders of magnitude

e.g. by C. Rothe from the University of Durham, United Kingdom: *Phys. Rev. Lett.*, Vol 96, Issue 16, 2006

Plasma expansion dynamics

e.g. by C. Janzen from the Fraunhofer-Institut für Lasertechnik (ILT), Germany: *Spectrochimica Acta Part B: Atomic Spectroscopy*, Vol 60, Issues 78, 2005

Spray analysis

e.g. by T. Streibl from the Universität der Bundeswehr, Germany: *Proc. SPIE 4308, High-Speed Imaging and Sequence Analysis III*, 45, 2001

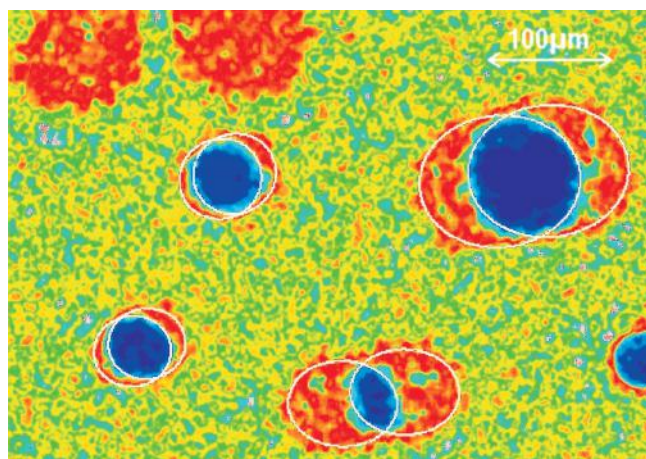

The image shows particles imaged with dual laser illumination under a certain angle. The separation of the shades is a direct measure of the particles position within the viewing direction. Using this information the particle size and shape can be directly analyzed by the particles shades. Figure reprinted with permission of Universität der Bundeswehr, Munich.



**STANFORD
COMPUTER
OPTICS**

Superior imaging intensified CCD cameras



4 Picos

Ultra high speed ICCD camera

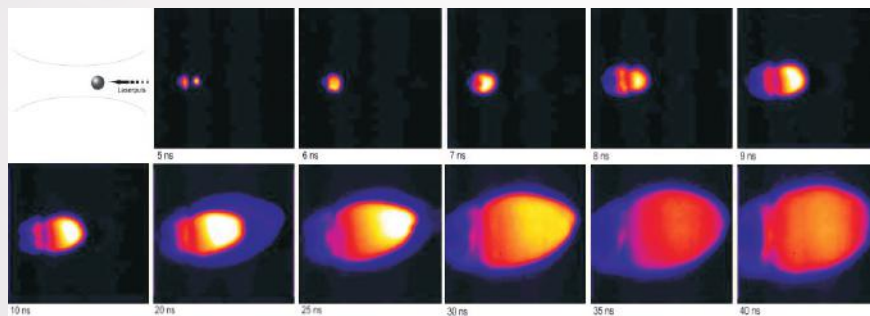

200ps highest speed shutter

Best imaging quality

Single photon detection

Compact and light design



Contact

Europe/Asia: Paul Hoess KG
Entenbachstr. 14 - 81541 Muenchen, Germany
Phone: +49 (0)89 652029 Fax: +49 (0)89 654817
E-mail: europe@stanfordcomputeroptics.com
www.stanfordcomputeroptics.com

USA/Canada: Stanford Computer Optics, Inc.
780 Cragmont Avenue - Berkeley, CA 94708, USA
Phone: +1(510) 527-3516 Fax: +1(510) 558-9582
E-mail: info@stanfordcomputeroptics.com
www.stanfordcomputeroptics.com





STANFORD
COMPUTER
OPTICS

Superior imaging intensified CCD cameras



4 Quik E

High speed ICCD camera

- 1.2ns highest shutter speed
- Best imaging quality
- Single photon detection
- Compact and light design



www.stanfordcomputer optics.com



**STANFORD
COMPUTER
OPTICS**



Superior imaging intensified CCD cameras

4 Quik E ICCD camera

High speed intensified CCD camera

Based on more than 25 years of experience in the field of high speed intensified imaging, Stanford Computer Optics, is developing pioneering, fast-gated intensified CCD (ICCD) cameras. The 4 Quik E ICCD camera sets new standards of reliable and outstanding, nanosecond resolved imaging and spectroscopy.

More detailed information

Best performance
CCD sensor 4

Time settings
& operation modes 5

Lens coupling 6

How to customize
the best 4 Quik E 7

High performance
image intensifier 8

Dimensions & mechanical
data, warranties 10

Applications. 11

Down to 1.2ns flat top, optical gating time

The 4 Quik E ICCD camera is equipped with high resolution image intensifier which provide excellent temporal resolution and highest sensitivity down to single photon. Equipped with a high resolution CCD sensor the 4 Quik E camera provides exceptional performance and superior image quality. Long-lasting and reliable electronics ensure trouble-free and undisturbed intensified imaging experience.

High performance and reliable electronics

In-house developed, custom-built electronics provide extreme low jitter, low intrinsic delay, excellent timing control with 0.1ns accuracy and flat top, true optical gating time of down to 1.2ns. The adjustable MCP voltage, multiple trigger options and various operation modes make the 4 Quik E most flexible and versatile intensified CCD camera for any scientific or industrial application.

Multi-purpose camera with nanosecond resolution

Optionally, the 4 Quik E ICCD camera can be equipped with up to 2MHz (on request 5MHz) continuous photocathode gating repetition rate and and increased signal amplification using a V-stacked double multi-channel plate (MCP) image intensifier.

Images cover & backside: Positive streamer discharge in pure argon imaged with the 4 Quik E camera. Reprinted figure with permission from U. Ebert et al., 2011 Nonlinearity 24 C1. Copyright (2011) by IOP Publishing Ltd. The figure was published originally in figure 7 of S. Nijdam et al., 2010 J. Phys. D: Appl. Phys. 43 145204.



Standard features and benefits

- Shortest shutter time 1.2ns
- Gating time from 1.2ns .. DC
- Internal delay times: 0 .. 80s
- Highly accurate timing control with step size of 0.1ns
- Extreme low jitter: 20ps
- High resolution image intensifiers with optical system resolution of >60lp/mm
- Spectral sensitivity from UV to red (depends on type of image intensifier)
- Brilliant sensitivity providing single photon detection
- Adjustable MCP voltage for 50db dynamic range in signal amplification
- Multiple exposure operation with up to 3.3MHz (burst mode) and 200kHz (continuous) optical shutter repetition rate
- Customized f/0.8 distortion free lens coupling between image intensifier and CCD
- High dynamic range up to 14bit resolution
- Multiple trigger options: 3x input; 3x output
- USB 2.0 (standard), USB 3.0 (optional) output
- Remote interface for real time camera control
- Compact and light system design
- 4 Spec E software

Optional features

- Nikon F-Mount Adapter
- Two discrete images with double frame mode (interframing time 500ns) with P46 phosphor
- High photocathode gating repetition rate up to 2MHz continuous; on request up to 5MHz available
- Adapters for various spectrometer
- Vacuum flange for UHV connection

Highlights

Fastest optical gating
down to 1.2ns

Superior image quality by
customized lens coupling

High system sensitivity with
single photon detection

Long-lasting electronics
(24 months warranty)

Compact and light design



Best performance CCD sensors

High resolution, high dynamic range imaging sensors

The 4 Quik E ICCD camera features high resolution intensified imaging for sharpest images with 1.2ns true optical gating. The 4 Quik E camera provides highest sensitivity with Gen II photocathodes and provides the best intensified image quality through customized lens coupling without compromising vignetting, distortion and coupling efficiency. All CCD sensors are front-illuminated types and provide best image quality with low noise and high fill factor.

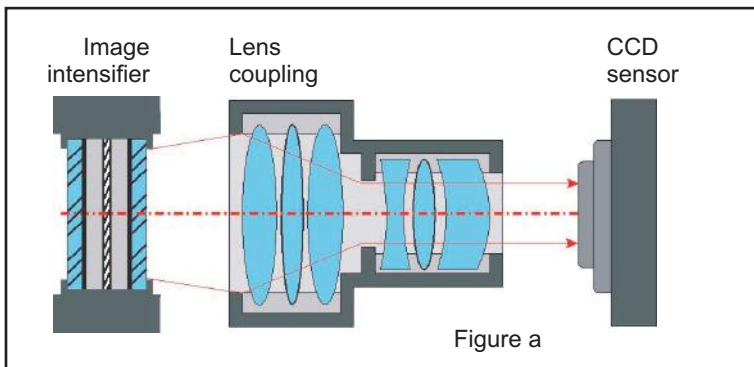

Figure a: Schematic sketch of the lens coupled intensified CCD camera. The appropriate coupling lens images the phosphor screen of the image intensifier to the CCD sensor.

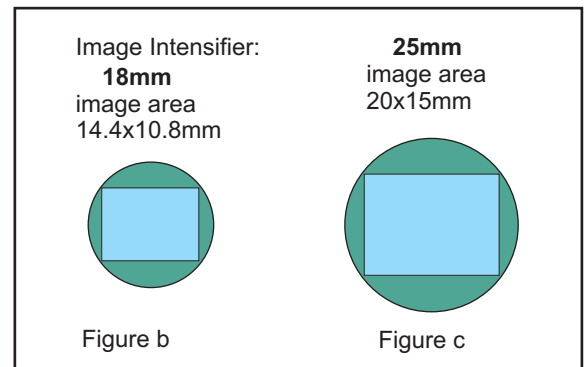

Figure b and c: Lens coupling provides full coverage of the CCD sensor (no dark corners) and highest image resolution.

Automatic continuous cleans

The CCD sensor is automatically cleared before triggering at trigger frequencies below 4Hz. This ensures the best and most efficient reduction of CCD sensor background noise.

High dynamic range

The CCD sensor provides up to 14bit dynamic range. Furthermore, the CCD sensor gain can be adjusted from 0 to 20db. In combination this results in 17bit dynamic range of the CCD sensor.

High fill factor

The interline CCD sensor provide highest fill factors using micro lens arrays on top of the active pixels.

CCD sensor cooling

Only measurements with very long exposure times need active cooling to increase S/N ratio. On request a regulated Peltier cooling ensures a cooled operation of the CCD sensor. This total encapsulated cooling system does not causes condensation and does not need vacuum or nitrogen atmosphere.

CCD sensor options

Parameter	High resolution HR CCD sensor	Standard resolution SR CCD sensor
Resolution	1360x1024	780x580
Pixel size [µm]	4.7x4.7	8.3x8.3
Camera interface	USB 2.0	USB 2.0
Binning options	full frame, 2 (2x2binning), ROI (region of interest)	
Dynamic range	12 or 14 bit	12 or 14 bitt
Video gain [dB]	full and ROI: 0..20db; 2x2: 0..25db	
Chip readout	Correlated double sampling, dark current corrected	



Time settings

Superior timing control with on-board delay generator

The **on-board digital** delay generator provides accurate timing control of the photocathode gating. All true flat top optical gating times are measured in single shot measurements. These measurements do not include the positive influence of signal jitter in integrating measurements.

Time settings	
Parameter	4 Quik E
Gate time [step size]	1.2ns ... 80s [100ps]
Delay time [step size]	0.1ns ... 80s [100ps]
Jitter	0.02ns
Minimal dead time between multiple exposures	300ns
Minimal interframing time (optional double frame mode*)	500ns
Trigger propagation delay	internal gate pulse: 60-65ns external gate pulse: 30-35ns

* image intensifiers with P46 phosphor screen

Operation modes

Single frame mode

The standard operational mode of our ICCD cameras allows the independent control of photocathode gating and CCD sensor.

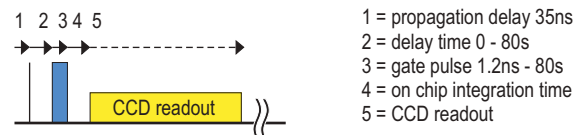

Integrate-on-chip: Programmed sequence (burst mode)

Any time sequence consisting of multiple gate and delay times can be applied to the photocathode. The minimum delay time is 300ns corresponding to 3.3MHz gate repetition rate.

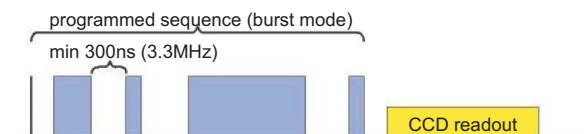

Integrate-on-chip: Multiple triggering (continuous)

This mode enables a continuous photocathode gating series on individual trigger signals with a predefined delay and gating time. The camera provides by default 200kHz, optionally 2MHz and on request 5MHz repetition rate. This mode is used e.g. for synchronization with high repetition rate lasers.



External gate control

Allows the direct control of the photocathode gating via an external TTL pulse and provides the shortest delay between external trigger and photocathode gating.



Optional: Double frame mode

Image intensifiers with P46 phosphor screen allow to capture two separate full-size, full-resolution images with a interframing delay as short as 500ns. This mode is applied e.g. Particle Imaging Velocimetry (PIV) or particle size analysis.

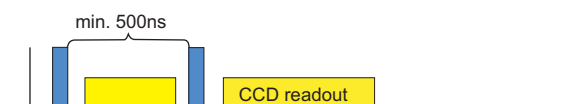

Lens coupling system

The lens coupled ICCD cameras provide superior image quality.

All 4 Quik E ICCD cameras are equipped with the in-house developed, customized f/0.8 lens coupling system. It provides superior imaging quality without compromising distortion, resolution and vignetting. In contrast to other claims the lens coupled ICCD camera systems provides single photon detection and high S/N

ratio at low light environment. The stray light is reduced using convenient anti-reflex coatings which results in magnificent optical contrast. Furthermore, in combination with the adjustable MCP voltage it proves high dynamic range, large linearity and ensures a great life span of the imaging system.

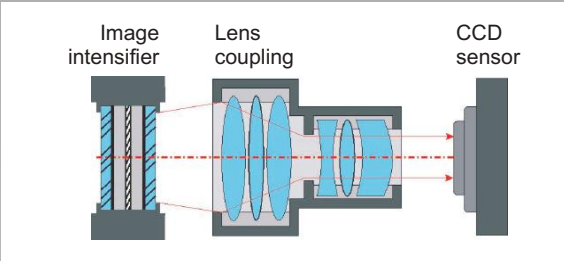
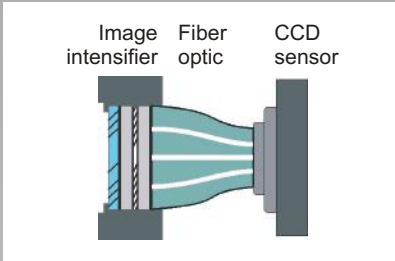
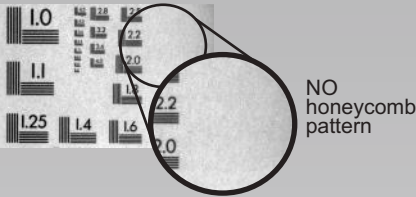
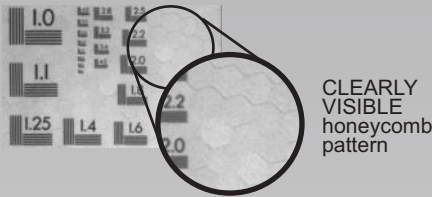
Coupling image intensifier		CCD sensor comparison	
Parameter	F/0.8 lens coupled ICCD camera	Fiber-optic coupled ICCD camera	
			
Example	 <p>NO honeycomb pattern</p>	 <p>CLEARLY VISIBLE honeycomb pattern</p>	
Advantages	<ul style="list-style-type: none"> + excellent coupling efficiency by F/0.8 lens + superior image quality highest modulation transfer function (cut off @ 180lp/mm) NO honeycomb pattern NO vignetting NO distortion (<0.03%) + cost efficient + variable setup (e.g. easy repair and replacement of each single component, especially image intensifier) 	<ul style="list-style-type: none"> + good coupling efficiency + compact design 	
Disadvantages	<ul style="list-style-type: none"> - stretched design 	<ul style="list-style-type: none"> - poor image quality lower modulation transfer function distortion > 3% CLEARLY visible honeycomb pattern - cost intensive - fixed structure e.g. no repair or replacement 	

In summary the fiber-coupled ICCD camera systems provide lower image quality and less flexibility in combination and maintenance. Whereas the often claimed much better coupling efficiency diminish after taking into account the coupling loss, the core-

cladding-ratio of the fibers and the significant loss of the fiber optic due to diameter reduction. On the other hand the customized F/0.8 lens coupling system provides best intensified image quality, high flexibility and excellent coupling efficiency.



4 Quik E family

Customize the optimum 4 Quik E ICCD camera for your application

The 4 Quik E ICCD camera enables the customization to the requirement and needs of your experiment. This guarantees best performance in combination with superior intensified imaging. Please follow the indicated four step process to get the best and most suiting ICCD camera for your application.

Customize the 4 Quik E camera in 4 steps:

1. Select the minimum gating time
2. Select the optimum image intensifier
3. Choose the ideal CCD sensor
4. Pick the required accessories

1. Minimum gate time

If the preferred minimum gate time is 1.2ns the 4 Quik E is the camera of your choice.

For shorter times please see our 4 Picos ICCD camera with min. gate time down to 200ps.



2. Image intensifier

2.1. Photocathode

- UV high QE
- optional: blue high QE
green high QE, red high QE
(see details on next page)
- input window: quartz
or MgF2 on request

2.2. Multi-channel plate (MCP)

- single or
- dual stage (optional)

2.3. Phosphor screen

- P43 standard
- P46 optional
(requested for 500ns fast
dual frame mode)

3. CCD sensor

3.1. Digital output

- standard: USB 2.0
- optional: USB 3.0 (2019)

3.1. Resolution of CCD sensor

- standard resolution:
780 x 580 pixel
- high resolution:
1360 x 1024 pixel

3.2. Dynamic range of CCD sensor

- 12bit or
- 14bit

Please contact our sales team to get assistance and further details to these options.

4. Selection of optional accessories and adapters

Item-No.	Name of product	Description
LMA-...	lens mount adapter	selection of adapter for various lens mount systems (e.g. F-mount, EOS) providing full aperture and reduced stray light by black anodized aluminum
SGA-...	spectrograph adapter	selection of adapter for all common spectrograph manufacturer e.g. Acton, Horiba and Jobin Yvon, others on request
VF	vacuum flange	customized flange to connect the ICCD camera to any vacuum tube
SMB-BNC	SMB-BNC	SMB - BNC adapter cables in any length
IOL-...	input objective lens	various input objective lenses e.g. Pentax UV lens 25mm, F2.8-16; Pentax UV lens 78mm, F3.8-16F3.8-1, others on request

High performance image intensifier

Guidance to make the right choices in order to get the most suitable image intensifier.

The image intensifier is a key component of each ICCD camera. This section deals with the fundamental characteristics of image intensifiers and their options. Different applications of ICCD cameras have different demands and requirements on the camera and thus on the image intensifier.

Following questions need to be addressed

- What are the spectral characteristics of the illumination?
→ Does determine the suitable photocathode.
- How fast need to be the shutter/shortest gating time?
→ Highest shutter speed does have some constrains to e.g. size of the image intensifier.
- How much light is there?
→ Dual stage MCP's have better performance at low light environments but less .
- High speed or low light imaging?
→ Does determine the suitable phosphor screen.

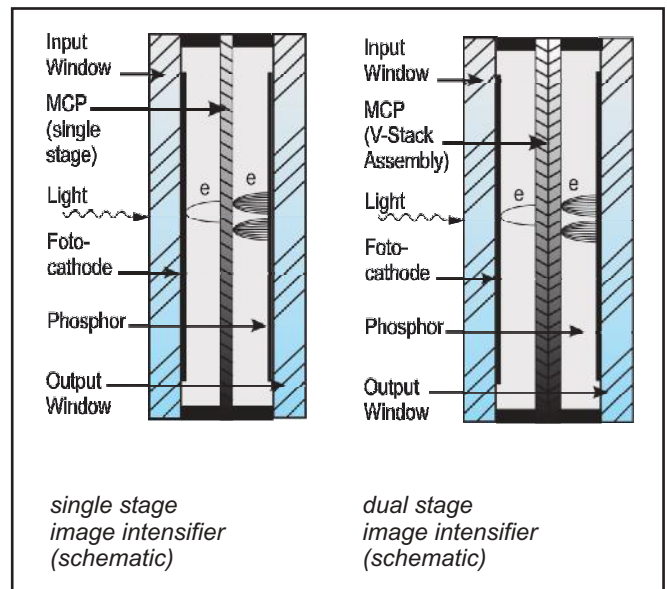

First the incoming photon releases an electron in the photocathode, second the electron is accelerated and amplified to an electron avalanche within the multi-channel plate (MCP), third the accelerated electrons are converted into photons by the phosphor screen.

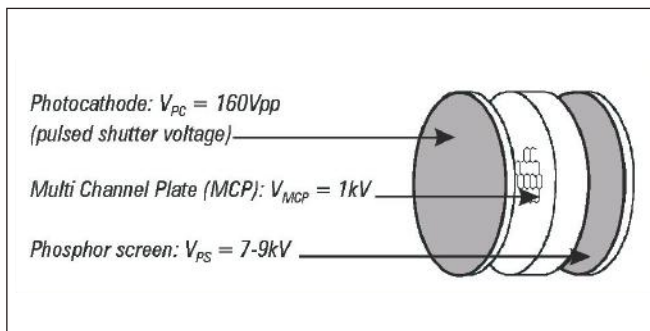

New: Gen II High QE photo cathodes

The new Gen II high Quantum Efficiency photo cathodes are providing the best spectral responsibility performance....

Photocathodes

	Type	Spectral range
Standard	UV High QE	approx. 180 - 700nm
Optional	UV High QE MgF2	approx. 110 - 700nm
	Blue High QE	approx. 200 - 700nm
	Green High QE	approx. 360 - 700nm
	Red High QE	approx. 400 - 900nm



Image intensifier specifications

Shutter speed

The shutter speed is limited by the speed of light since any electromagnetic signal does not travel faster.

Input window

The standard input window is made of quartz. This limits the UV spectral range below 165nm. The optional Magnesium Fluoride (MgF2) window enables measurements down to 110nm.

Photocathode

Photocathodes define the sensitivity and the spectral response of the image intensifier.

Phosphor screen

There are three important considerations in choosing a luminous (phosphor) output screen.

1. spectral emission range
2. efficiency
3. phosphor decay time

The P43 phosphor screen has a higher efficiency, however, a longer decay time. For fast applications e.g. double frame mode with interframing time of 500ns the P46 phosphor screen is necessary to avoid ghost images from the previous exposure.

Multi-channel-plate (MCP)

Image intensifiers can be equipped with single or double stage MCP's. The single stage MCP features excellent signal gain and fits most applications of the ultra high speed ICCD cameras.

The V-stacked double MCP's are especially used for extreme low light environments. The increased electron multiplication provide single photon detection with increased signal to noise ratio and reduced ion feedback noise. Therefore, the double MCP is mainly used for long exposure measurements and extreme low light applications

Upper graph: Spectral responsivity [mAW]
Lower graph: Quantum Efficiency [%]

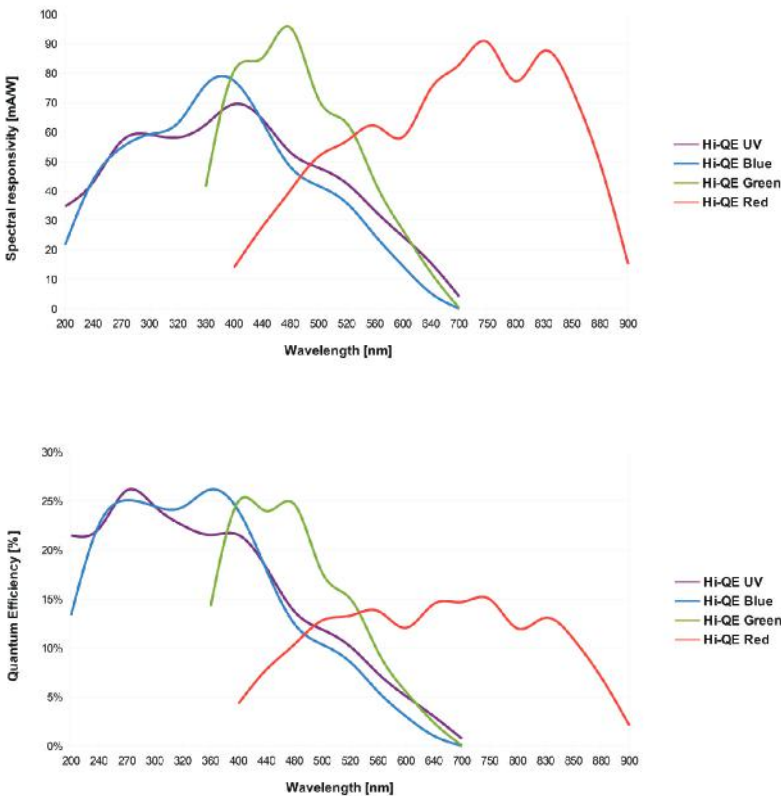

Phosphor screen

Type	Composition	Efficiency	Decay time		Emission spectral range
			90% to 10%	10% to 1%	
P43	Gd ₂ O ₂ S:Tb	185 ph/e @6kV	1.5ms	3.3ms	360 - 680nm
P46	Y ₃ Al ₅ O ₁₂ :Ce	90 ph/e @6kV	0.2µs	10µs	490 - 620nm

Micro-channel-plate (MCP)

Type	Electron multiplication	S/N ratio	Notice
Single stage	up to 10 ³	very good	best image quality
Double stage	up to 10 ⁶	excellent	highest sensitivity

Dimensions

Compact and light design

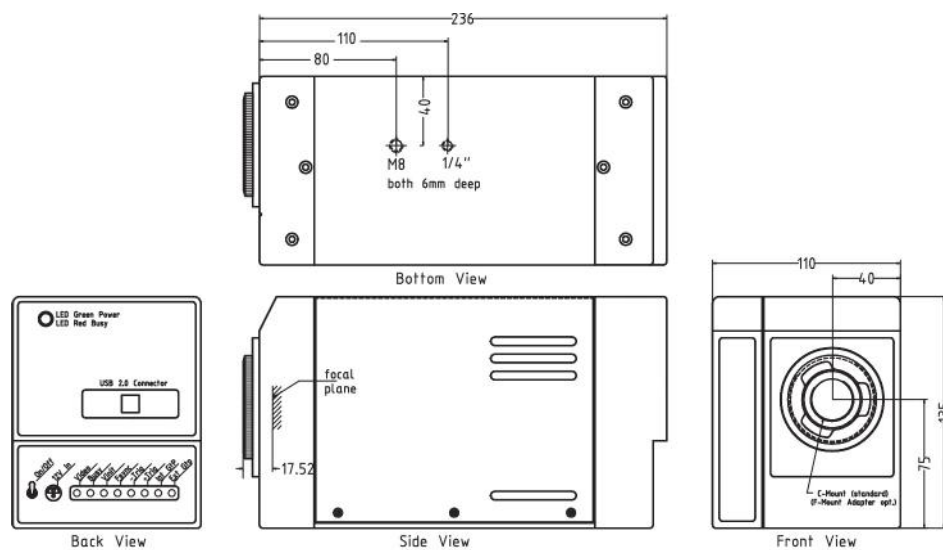

Mechanical and environmental data

Parameter	Description
Camera weight (all in one)	3kg / 6.6lb
Camera dimensions without lens	248 x 110 x 135mm (l x w x h)
Camera mount	1/2" and M8 mounting holes
Operating humidity	25..95%, non condensing
Operating temperature	0°C 50°C / 32°F 122°F
Performance specification	10°C 40°C / 50°F 104°F
Operating limits	-10°C 50°C / 14°F 122°F
Shock and vibration	60g accel. shock, 7g Vibration (11 200Hz), excludes MCP in direct frontal impact
Voltage	90..260VAC

Extended warranty on all products from Stanford Computer Optics

2 years on mechanics and electronics
Stanford Computer Optics Inc. warrants all new products to be free from defects in materials and workmanship for 24 months from the date of dispatch.

1 year on image intensifier
Image intensifiers are subject to the original manufacturer's warranty conditions. It comprises a warranty of 12 months. In case of any defect the Paul Hoess KG or Stanford Computer Optics Inc. will assist for repair or replacement.

Warranty restriction
Warranties do not cover normal wear, misuse, negligence or accident. They do not apply to goods which have been misused, altered, inadequately maintained, stored incorrectly, or negligently installed or serviced.



Applications

4 Quik E ICCD camera provides user-friendly intensified imaging for numerous, different applications

Hyper-Rayleigh measurements

e.g. by M. R. Beaudin from the Carleton University, Canada: Chem. Mater., 18, 1079-1084, 2006

Combustion imaging

e.g. by I.Y. Ohm from the Seoul National University, South Korea: International Journal of Automotive Technology, Vol. 12, Issue 5, 2012

Electrical breakdown measurements

e.g. by K. Schoenbach from the Old Dominion University, United States: Plasma Sources Sci. Technol., Vol. 17, Issue 2, 2008

Fluorescence spectroscopy

e.g. by S.E. Saari from the Tampere University of Technology, Finland: Atmospheric Environment, Vol. 71, 2013

Spray and flow imaging

e.g. by H. K. Suh from the Hanyang University, South Korea: Atomization and Sprays, Vol. 17, Issue 7, 2007

Laser induced breakdown spectroscopy (LIBS)

e.g. by S. T. Järvinen from the Tampere University of Technology, Finland: Spectrochimica Acta Part B: Atomic Spectroscopy, Vol. 86, 2013

Raleigh scattering

e.g. by J. Campo from the University of Antwerp, Belgium: Optics Express, Vol. 17, Issue 6, 2009

Time-resolved optical emission spectroscopy

e.g. by R. M. van der Horst from the Eindhoven University of Technology, The Netherlands: J. Phys. D: Appl. Phys., Vol. 45, Issue 34, 2012

Streamer discharge research

e.g. by U. Ebert from the CWI Amsterdam, The Netherlands: Nonlinearity, Vol. 24, Issue 1, 2011

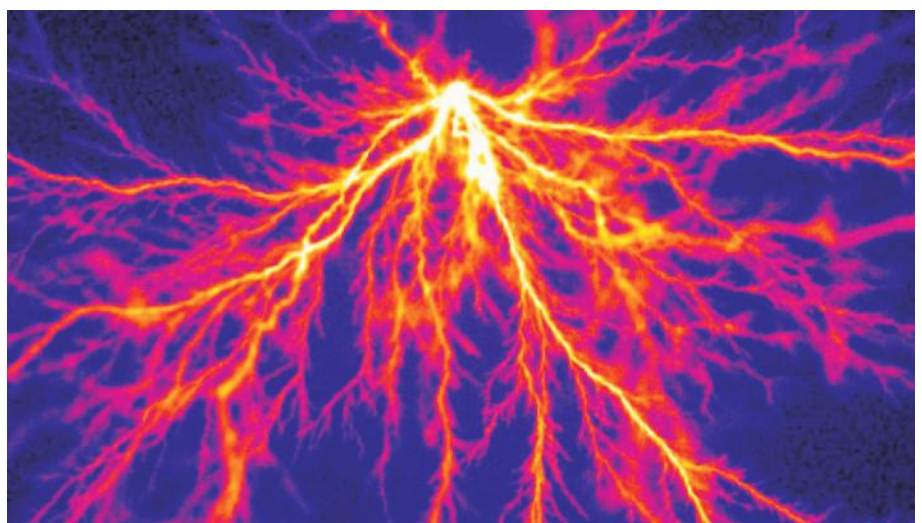
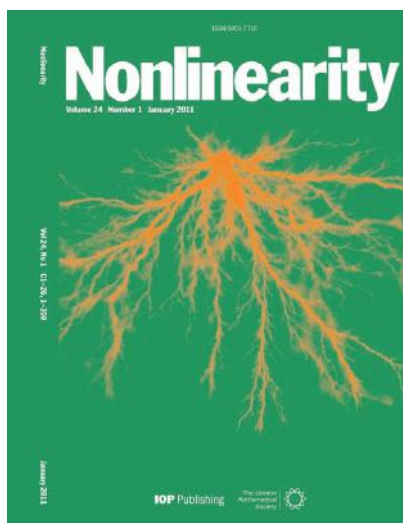

Feather-like structures in a positive streamer discharge in pure argon at room temperature and atmospheric pressure. The image is recorded with the 4 Quik E ICCD camera and represents about 40mm of the discharge gap with the electrode tip in the top center. The blurred structures are out of focus.

Reprinted figure with permission from U. Ebert et al., 2011 Nonlinearity 24 C1. Copyright (2011) by IOP Publishing Ltd. The figure appeared also on the cover of Nonlinearity Vol. 24 (2011) and was published originally in figure 7 of S. Nijdam et al., 2010 J. Phys. D: Appl. Phys. 43 145204.



**STANFORD
COMPUTER
OPTICS**

Superior imaging intensified CCD cameras



4 Quik E

High speed ICCD camera

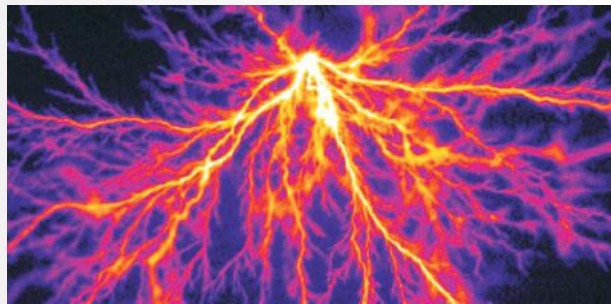

1.2ns high shutter speed
Best imaging quality
Single photon detection
Compact and light design



Contact

Europe/Asia: Paul Hoess KG
Entenbachstr. 14 - 81541 Muenchen, Germany
Phone: +49 (0)89 652029 Fax: +49 (0)89 654817
E-mail: europe@stanfordcomputeroptics.com
www.stanfordcomputeroptics.com

USA/Canada: Stanford Computer Optics, Inc.
780 Cragmont Avenue - Berkeley, CA 94708, USA
Phone: +1(510) 527-3516 Fax: +1(510) 558-9582
E-mail: info@stanfordcomputeroptics.com
www.stanfordcomputeroptics.com

